

DC500

Door closer with Cam-Motion® technology and guide rail



ASSA ABLOY DC500

- Door closer with Cam-Motion® technology and height-adjustable guide rail G195 or standard guide rail G193
- Fulfills barrier-free building requirements (EA / CEN TR 15894)
- Certified in compliance with EN 1154, size 1-4
- For single action doors up to 1100 mm wide
- Can be used in four installation types: hinge and non-hinge sides in standard and frame installation
- Suitable for fire and smoke protection doors

Characteristics of DC500

- Can be used with integrated concealed mounting plate, suitable for fire and smoke protection doors
- Can be used for left and right-handed doors
- 14 mm height adjustable arm system for ease of fitting
- Closing speed, latching speed and backcheck adjustable via front facing regulating valves
- Thermodynamic valves for consistent performance
- Variable adjustable closing force
- Opening angle up to 160°
- Effective backcheck and latching speed range adjustable
- Large range of applications
- Standard colours: silver EV1; white, similar to RAL9016; brown, similar to RAL8014; black, similar to RAL9005, stainless steel
- Customised finishes available on request



CE	Abloy Oy, PO Box 108 80101 Joensuu Finland	16	3	8	4	1	1	4
Dangerous substances: None								

Characteristics of guide rail G195

- Height-adjustable by 2 mm for tolerance
- Concealed fastening screws
- Installation dimensions: see diagram

Characteristics of standard guide rail G193

- Without protective cover
- Visible fastening screws
- Installation dimensions: see diagram (dimensions in brackets)

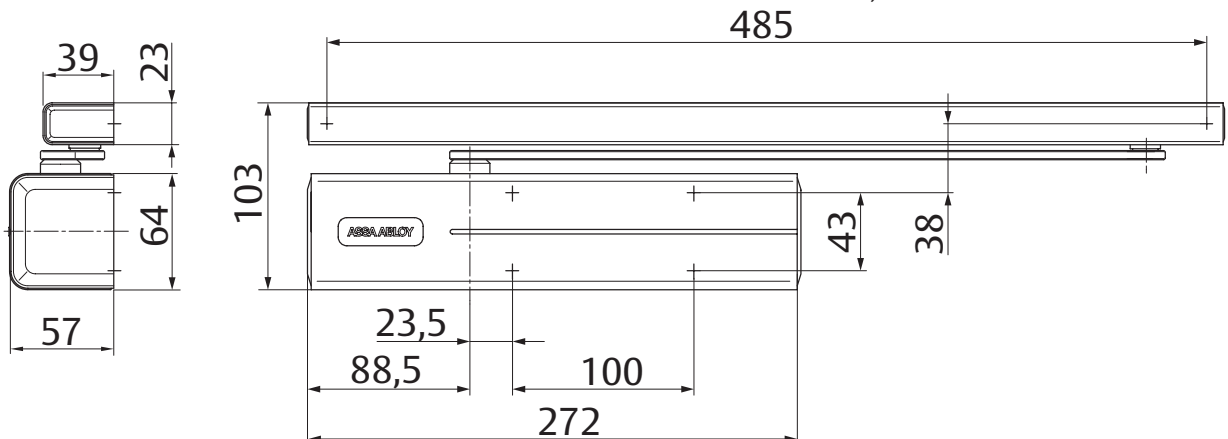

DC500

Technical attributes

Technical attributes	
Closing force	EN 1-4
Door width up to	1100 mm
Suitable for fire doors	Yes
Handing	Left / right handed
Mounting method	Standard and frame installation
Closing speed	Variable between 170°-10°
Latching speed	Variable between 10°-0°
Backcheck	Variable above 75°
Max. door opening angle hinge side	ca. 170°
Max. door opening angle non-hinge side	Ca. 120°
Weight	2.7 kg
Height	64 mm
Depth	58 mm
Length	272 mm
Certified in compliance with	EN 1154
CE marking for building products	Yes

The advantages at a glance

Customer segment	Advantages
Project planners	<ul style="list-style-type: none"> - Extensive range of uses: Fire and smoke protection doors as well as standard doors - Modern design - Compact design - Fulfils barrier-free building requirements (EA / CEN TR 15894) - Same dimensions and design with and without mounting plate
Builders	<ul style="list-style-type: none"> - One drilling template overall - Adjustable to nearly all door and frame types - Quick and easy installation - Quickly and easily adjustable - Suitable for left and right handed doors for standard and frame mounting on hinge and non-hinge side
Trade	<ul style="list-style-type: none"> - Reduced inventory costs due to modular product range - One single product suitable for a large variety of mounting positions - Complementary accessories available for the whole product range
User	<ul style="list-style-type: none"> - Largely unaffected by temperature fluctuations thanks to thermodynamic valves - Easier door opening and improved accessibility due to rapidly decreasing torque

Our service for you: here you can see the individual advantages of our door closer models for your respective field of business.

Specifications for DC500

ASSA ABLOY Door Closer DC500 with Cam-Motion® technology and guide rail in compliance with EN 1154

- Closing power continuously adjustable, EN size 1-4, for doors up to 1100 mm wide
- Closing speed, latching speed and backcheck continuously adjustable
- Can be used with integrated concealed mounting plate, suitable for fire and smoke protection doors
- CE approved
- 14 mm height adjustable arm system for ease of fitting
- Standard and frame mounting on hinge and non-hinge side of the door
- Suitable for left and right handed doors

Accessories:

- Standard guide rail G193
- Height-adjustable guide rail G195
- Mounting plate A120
- Mounting plate A130 for guide rail G193 and G195
- Angle bracket A104 for guide rail G193
- Mechanical opening damper A153
- Mechanical hold-open device A152 (not for fire and smoke protection doors)
- Glass door shoe A166
- Screening plate A190

Colour:

- Silver EV1
- White, similar to RAL9016
- Brown, similar to RAL8014
- Black, similar to RAL9005
- Stainless steel
- Stainless steel
- Customised finish

You can find the complete specification on the internet at: www.assaabloy.de

DC500

Dimensional drawings

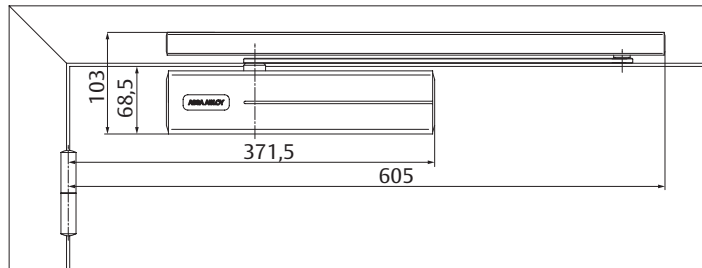
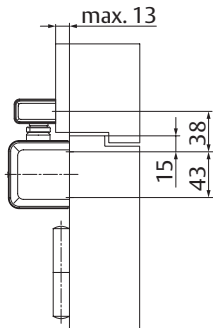

Space required on doors for standard installation on hinge side

Left handed shown in diagram
Right handed is the reverse

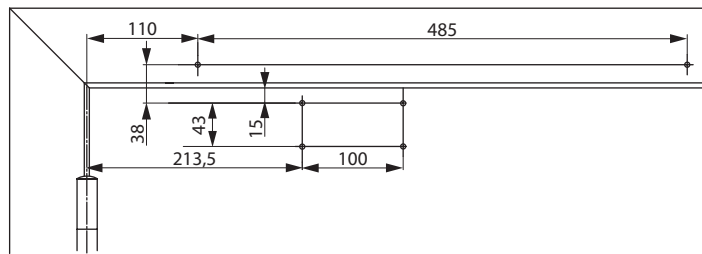
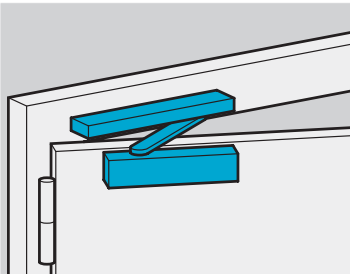

Installation dimensions for direct standard mounting on hinge side

Left handed shown in diagram
Right handed is the reverse

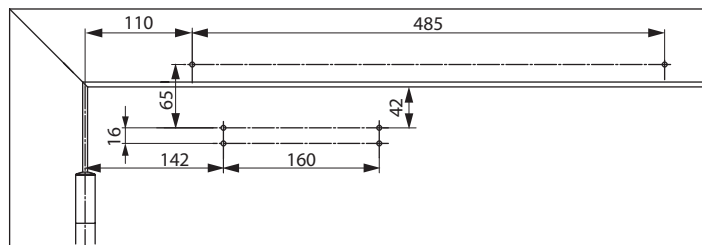

Installation dimensions with mounting plate for standard mounting on hinge side

In compliance with EN 1154, Supplement 1, or for doors where direct mounting is not possible.
Left handed shown in diagram
Right handed is the reverse

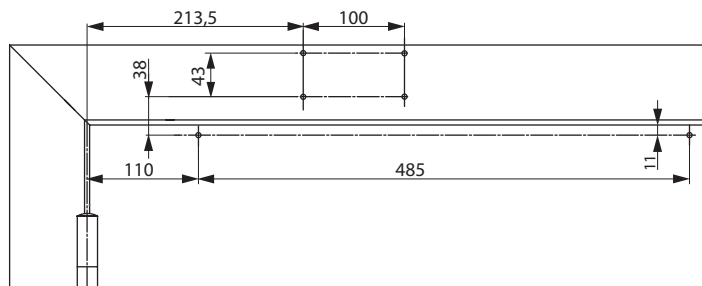
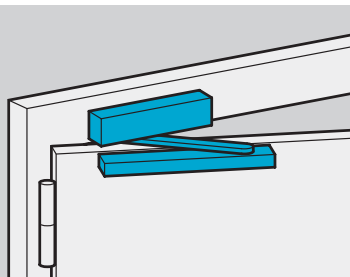

Installation dimensions for direct frame mounting on hinge side

Closer on hinge side of door frame.
Left handed shown in diagram
Right handed is the reverse

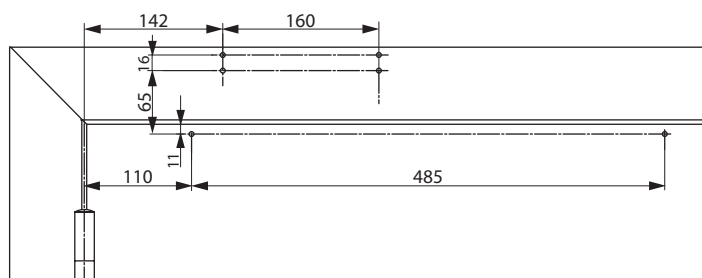

Installation dimensions with mounting plate for frame mounting on hinge side

Closer on hinge side of door frame. For doors where direct mounting is not possible.
Left handed shown in diagram
Right handed is the reverse

DC500

Dimensional drawings

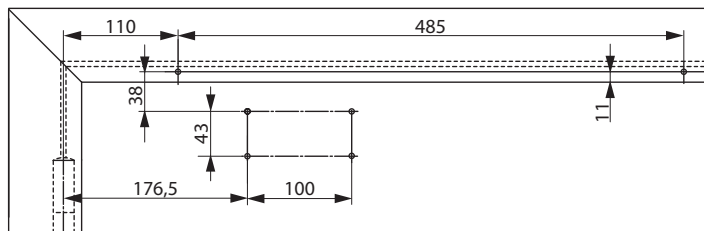
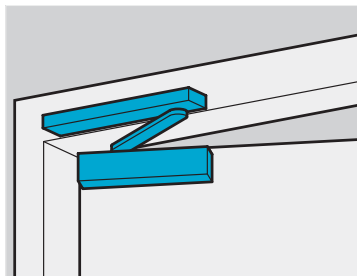

Installation dimensions for direct standard mounting non hinge side
 Right handed door shown in diagram
 Left handed door is the reverse

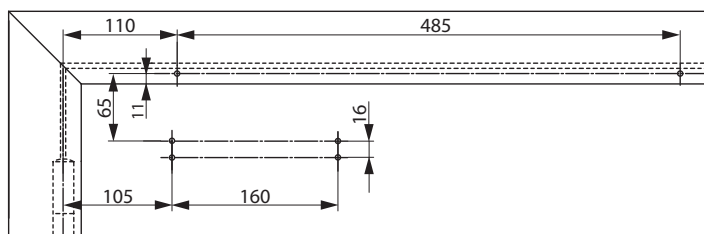

Installation dimensions with mounting plate for standard mounting non hinge side
 For doors where direct mounting is not possible
 Right handed door shown in diagram
 Left handed door is the reverse

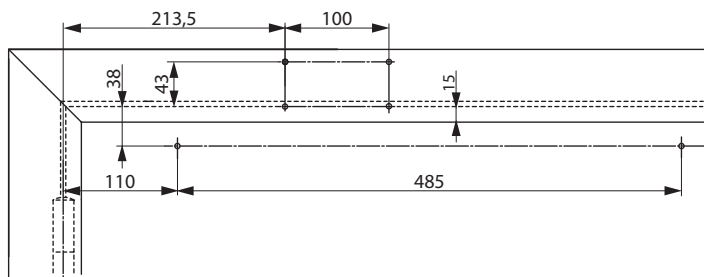
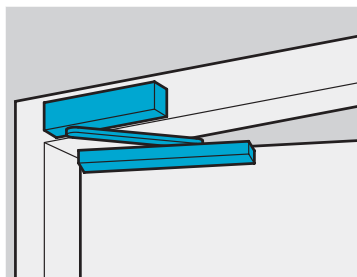

Installation dimensions when mounted directly onto the frame non-hinge side
 Closer on non-hinge side of door frame
 Right handed door shown in diagram
 Left handed door is the reverse

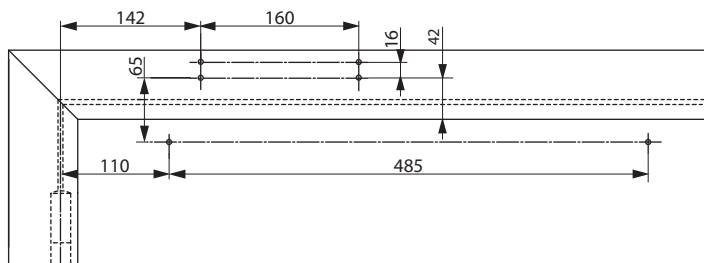

Installation dimensions with mounting plate for frame mounting non-hinge side
 Closer on non-hinge side of door frame. For doors where direct mounting is not possible.
 Right handed door shown in diagram
 Left handed door is the reverse

DC500

Accessories and order placement information

Stainless steel full cover

For DC500 and DC700



Stainless steel design cover

For DC500 and DC700



Opening damper A153

Helps to prevent the door and door handle from hitting a return wall.

Simple fitting into guide rail.

Opening damper continuously adjustable up to an opening angle of max. 130°.

Does not replace a door stop.

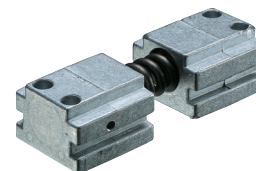

Hold-open device A152

Mechanical hold-open device for doors which sometimes need to be secured in the open position.

Simple fitting into guide rail G193 and G195.

Hold-open angle max. 130°

Not approved for use on fire and smoke protection doors

Continuously adjustable holding force



Screening plate A190

Screening plate A190

Use on doors with narrow profiles and glass filling as cover of the back of the door.



Designation / Item	Order no.
DC500, EN size 1-4, silver EV1	DC500-----DEV1-
DC500, EN size 1-4, white, similar to RAL9016	DC500-----D9016
DC500, EN size 1-4, brown, similar to RAL8014	DC500-----D8014
DC500, EN size 1-4, black, similar to RAL9005	DC500-----D9005
DC500, EN size 1-4, stainless steel, ASSA ABLOY design	DC500-----D35--
DC500, EN size 1-4, customised finish	DC500-----DXXXX
Guide rail G193, silver EV1	DCG193-----EV1-
Guide rail G193, white, similar to RAL9016	DCG193-----9016
Guide rail G193, brown, similar to RAL8014	DCG193-----8014
Guide rail G193, black, similar to RAL9005	DCG193-----9005
Guide rail G195, silver EV1	DCG195----DEV1-
Guide rail G195, white, similar to RAL9016	DCG195----D9016
Guide rail G195, brown, similar to RAL8014	DCG195----D8014
Guide rail G195, black, similar to RAL9005	DCG195----D9005
Guide rail G195, stainless steel	DCG195----D35--
Guide rail G195, bespoke finish	DCG195----DXXXX

Designation / Item	Order no.
Mounting plate A120, galvanised	DCA120-----40
Mounting plate A130, silver EV1	DCA130-----EV1-
Mounting plate A130, white, similar to RAL9016	DCA130-----9016
Mounting plate A130, brown, similar to RAL8014	DCA130-----8014
Mounting plate A130, black, similar to RAL9005	DCA130-----9005
Mounting plate A130, customised finish	DCA130-----XXXX
Mounting plate A136, non-hinge side, for Guide Rail G193 and G195, 40 mm, silver EV1	DCA136-----EV1-
Glass door shoe A166, silver EV1	DCA166-----EV1-
Angle bracket A104, silver EV1	DCA104-----EV1-
Angle bracket A104, RAL9016 white	DCA104-----9016
Angle bracket A104, brown, similar to RAL8014	DCA104-----8014
Angle bracket A104, black, similar to RAL9005	DCA104-----9005
Hold-open device A152	DCA152-----
Opening damper A153	DCA153-----
Replacement plate A124, galvanised	DCA124-----40
Screening plate A190, stainless steel	DCA190-----35--